

2025

VALID TO 31 Dec

Australasian Certification Authority for
Reinforcing and Structural Steels Ltd



PRODUCT CERTIFICATION
www.steelcertification.com

CERTIFICATE OF APPROVAL

Product Conformity Certification

This is to certify that

Shiu Wing Steel Limited

at

**5 Lung Yiu St
Tuen Mun, Hong Kong**



has satisfied the Authority that it complies with the rules of the ACRS Product Certification Scheme and the relevant ACRS Quality and Operations Assessment Procedures. Where appropriate, and as listed below, it has further satisfied the Authority that it manufactures and/or supplies products that conform with the Standards listed below, and is entitled to use the ACRS mark in relation to the products listed on this certificate.

SCOPE OF CERTIFICATION

Reinforcing Bar Manufactured in straight lengths to AS/NZS 4671:2019

Products listed on this Manufactured Product certificate may be relied upon as having the benefit of ACRS Product Scheme certification after any subsequent processing only if cut, or bent, or welded by an ACRS certified processor. For Approval of processed reinforcing bar, refer to the bar processor's ACRS Fabricated Product certificate.

This certificate remains the property of the Authority and is issued subject to the Regulations of the Authority.

CERTIFICATE NUMBER	VERSION	FIRST APPROVAL	ISSUE DATE	EXPIRY DATE
211202	1	17 December 2021	01 January 2025	31 December 2025

SIGNED FOR ACRS

Andrew Wheeler,
Executive Director

AUSTRALASIAN CERTIFICATION AUTHORITY FOR REINFORCING AND STRUCTURAL
STEELS LTD | ABN: 40 096 692 545 | PO BOX 1369, CROWS NEST NSW 1585, AUSTRALIA

To check the validity of this certificate please scan the above Static QR Code with the ACRS
Cloud App or visit www.steelcertification.com

Cert. Ref.: 157-01 211202

This document is uncontrolled when printed View original at www.steelcertification.com

JAS-ANZ



www.jas-anz.org/register
Accreditation certificate
number Z5221212AC

2025

VALID TO 31 Dec

Australasian Certification Authority for
Reinforcing and Structural Steels Ltd



PRODUCT CERTIFICATION
www.steelcertification.com

CERTIFICATE OF APPROVAL

Product Conformity Certification

Certificate No: 211202
Shiu Wing Steel Limited

at
5 Lung Yiu St
Tuen Mun, Hong Kong



Products assessed by ACRS to the following Standards:

AS/NZS 4671 Grade 500N Ribbed Bar 12 to 36 mm

Approved Company Information

Bar Markings

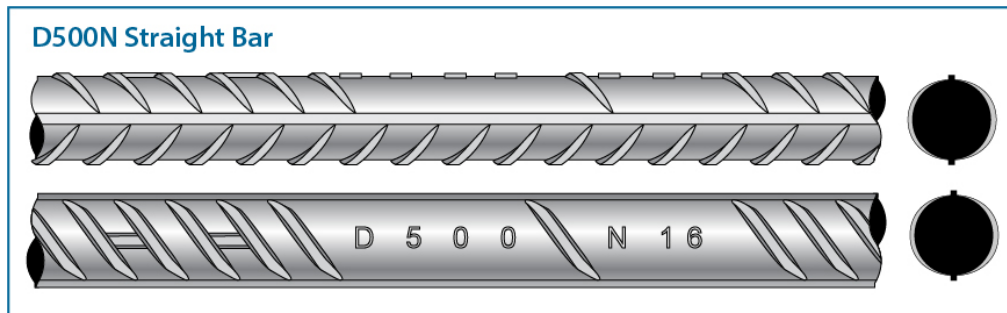

Tag



To check the validity of this certificate please scan the above Static QR Code with the ACRS
Cloud App or visit www.steelcertification.com

Cert. Ref.: 157-01 211202

This document is uncontrolled when printed View original at www.steelcertification.com

JAS-ANZ



www.jas-anz.org/register
Accreditation certificate
number Z5221212AC